

Home computer NMS8250/00/16/19

Service
Service
Service

NMS8255/00/16/19

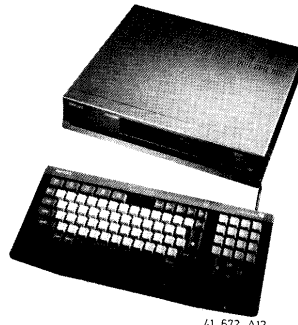

41 672 A12

Repair Method

Repair method NMS8250/NMS8255

PAG
1

APPENDIX
- Bus errors

24

Subject to modification
4822 727 15847
Printed in The Netherlands
© Copyright reserved

Published by
Service Consumer Electronics

CS 7 946

Scanned and converted to PDF by HansO, 2001

CONTENTS	PAG
1. INTRODUCTION	2
2. REPAIR METHOD NMS8250/NMS8255	3
3. KEYBOARD TEST	4
3.1 ERR 001	4
3.2 ERR 002	4
3.3 Other keyboard errors	4
4. JOYSTICK TEST	5
4.1 ERR 101	5
4.2 ERR 102	5
4.3 ERR 103	5
4.4 Other joystick errors	5
5. RAM TEST	6
5.1 ERR 211	6
5.2 ERR 212	6
5.3 ERR 215	7
5.4 ERR 221	8
5.5 ERR 241	8
5.6 ERR 261	8
5.7 ERR 271	9
5.7 ERR 281	10
6. CASSETTE TEST	11
7. SOUND TEST	12
7.1 ERR 400	12
7.2 Other sound problems	12
8. I/O TEST	13
9. PATTERN TEST	14
9.1 Character set mode 40	14
9.2 Character set mode 80	14
9.3 Colour stripes	14
9.4 Bar pattern	14
9.5 Sprite test	15
9.6 Video RAM test	15
9.6.1 ERR 615	15
9.6.2 ERR 621	15
9.6.3 ERR 671	15
9.6.4 ERR 681	15
10. SUM CHECK TEST	16
10.1 Sum check test ROM	16
10.2 Sum check BASIC ROM	16
10.3 Sum check expansion ROM	16
10.4 Sum check disk ROM	16
11. RTC TEST	17
11.1 ERR 711	17
11.2 ERR 715	17
11.3 ERR 721	17
11.4 ERR 771	17
11.5 ERR 799	17
12. PRINTER TEST	18
12.1 ERR 801	18
12.2 ERR 810	18
13. ERR 990. ERRONEOUS INTERRUPT SIGNAL	19
14. ERR 999. NO INTERRUPT SIGNAL FROM VDP	20
15. FLOPPY DISK DRIVE INTERFACE TEST	21

2. REPAIR METHOD NMS8250/NMS8255

- Remove external cartridge(s).
- Connect a TV or monitor.
- Switch on computer.
- Power LED on.

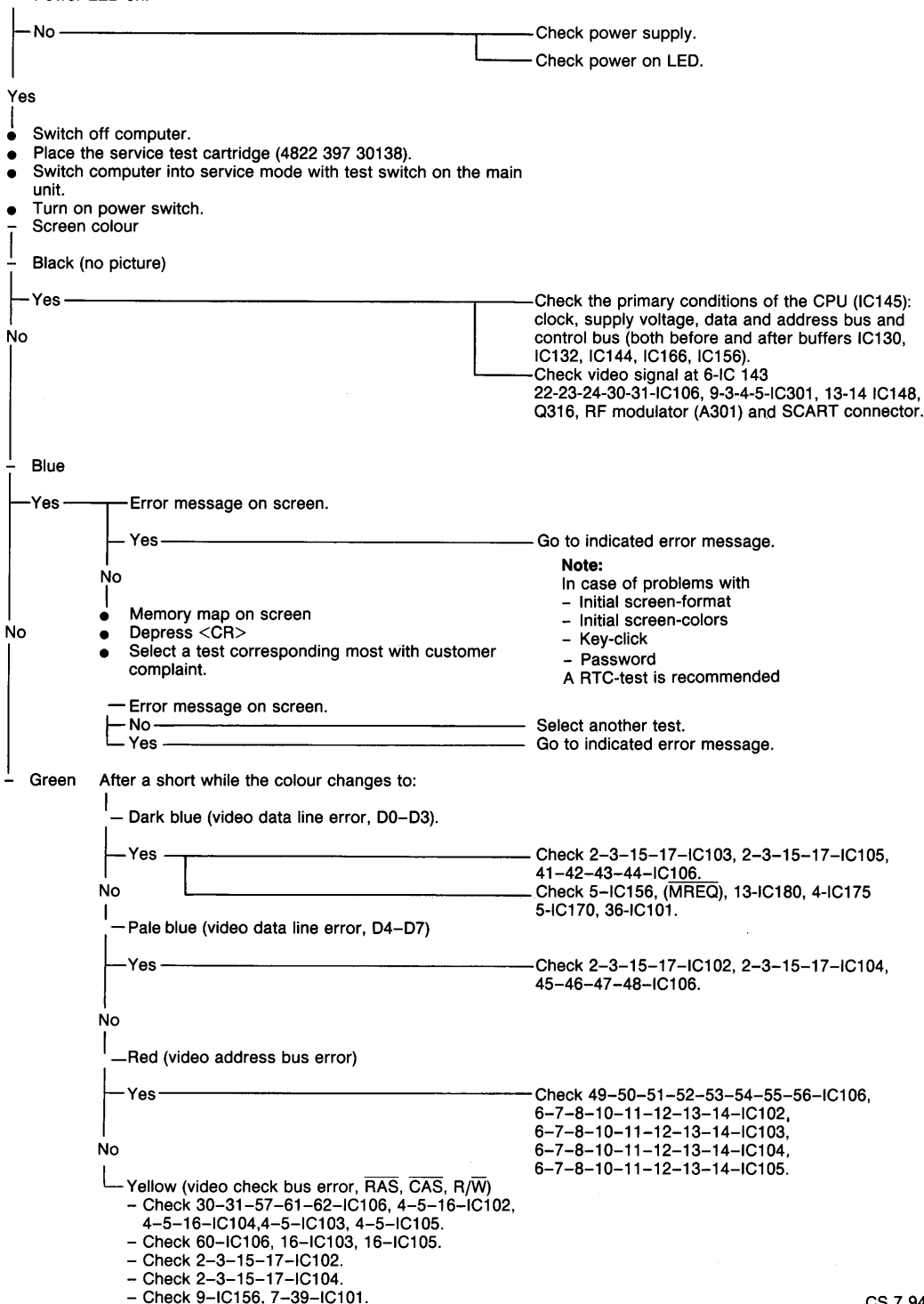

3. KEYBOARD TEST <TAB>

With the option <CTRL> + <F1> (repeat option) no error message occurs with a continuously closed key.

If during start-up of the test cartridge an error is detected in the keyboard, the programme goes directly to the keyboard test; within 10 seconds the service mode should be switched off.

Depressing of keys: CODE, F1, F2, F3, F4, F5, TAB, INS, DEL and ESC successively results in figures 0 through 9 on the screen.

Depressing of keys: CTRL, CAPS, GRAPH, SPACE, the cursor keys, RETURN, BS, SELECT, CLR/HOME and STOP results in an * on the screen.

Ten keys (numeric keys) are not supported with this test ROM Cartridge.

To obtain pulses on pins

74-75-76-77-78-79-80-81-82-IC101 a key from rows Y0 or Y1 - Y8 has to be depressed (repeat option switched on!).

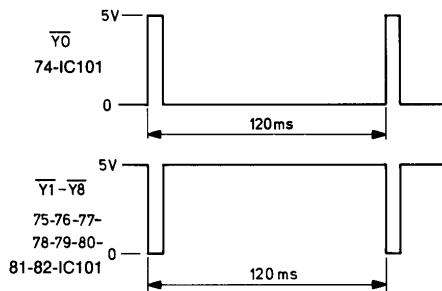

39804A12

3.1 ERR 001. Several keys activated simultaneously

With ERR 001 the number of simultaneously activated keys is indicated.

- ERR 001

- Characters appear on the screen without a key having been depressed.

Yes _____ Check 66-67-68-69-70-71-72-73-IC101.

No

- Depressing one key from one row results in several characters on the screen.
- Other keys from other rows function normally.
- Check this row (74-75-76-77-78-79-80-81-82-IC101).

3.2 ERR 002. Continuously closed keys

- ERR 002

- One key remains closed. Replace keyboard.

3.3 Other keyboard errors

- One key does not function. Replace keyboard.
- One entire row or column does not function.

Column _____ Check related column.
(66-67-68-69-70-71-72-73-IC101)

Row _____ Check related row.
(74-75-76-77-78-79-80-81-82-IC101).

4. JOYSTICK TEST <F1>

Operation of the joystick results in a corresponding change of direction of the cursor on the screen. In this way it is possible to detect an incorrect contact or a wire rupture in the joystick. Depressing of the action key results in a repeating cursor (≈ 100 times/min.). Depressing of a second action key (if present) results in a repeating cursor of 140 times/min. During the I/O test pulses are generated at pins TRGA1, TRGB1, STB1, TRGA2, TRGB2, STB2 (52-53-54-59-60-61-IC101).

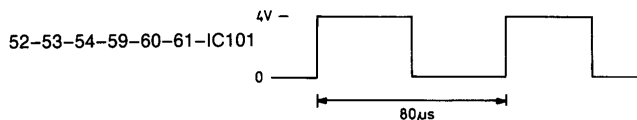

36 603 A7

4.1 ERR 101. Incorrect direction

- ERR 101
- Check if a switch in the joystick remains closed.
- Check 48-49-50-51-55-56-57-58-IC101.

4.2 ERR 102. 2 Actions on the same joystick

- ERR 102
- Check if two action switches remain closed.
- Check Q104, 52-IC101, 53-IC101 (for joystick 1).
- Check Q105, 59-IC101, 60-IC101 (for joystick 2).

4.3 ERR 103. Another joystick activated

- ERR 103
- With joystick connected

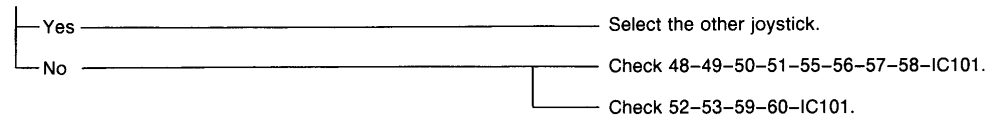

4.4 Other joystick errors

- Joystick does not function.
 - Check earth connection of joystick (pin 8).
- Action key does not function.
 - Check for wire rupture.
 - Action switch defective.

5. RAM TEST <F2>

The NMS8250 has a 128k users RAM divided over two banks of 64k.

IC133 and IC134 form bank 1 and IC135 and IC136 form bank 2. Keys <F1> and <F2> determine the bank to be tested.

A bank can be tested once or continuously.

If the option to test a bank is missing, the memory mapper will be addressable. Check in that case 8-IC111, 1-4-10-IC131, 1-IC150.

During start-up of the test programme a brief RAM test is performed.

5.1 ERR 211. RAM not present from C000 till FFFF.

During ERR 211 the contents of the accumulator is continuously written to memory location C000. In that case the various signal forms are:

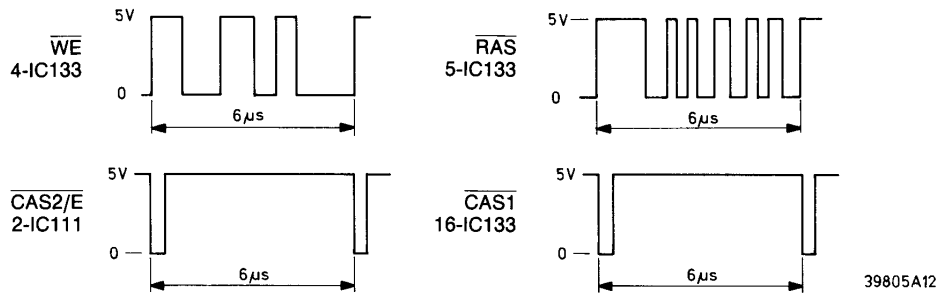

During ERR 211 $\overline{\text{RSEL}}$ (8-IC115) is high.

● ERR 211 (bank 1)

- Check 2-IC111 (CAS), 10-IC134, 46-IC101

Check 13-IC157 ($\overline{\text{RFSH}}$), 35-IC101, 4-5-IC132, 28-IC145

Check 11-IC123 ($\overline{\text{M1}}$), 34-IC101, 6-7-IC132, 27-IC145.

Check 8-IC115 ($\overline{\text{RSEL}}$), 9-IC101.

- Check 16-IC133 ($\overline{\text{CAS}}$), 16-IC134, 1-2-3-IC111, 2-7-IC149, 2-3-IC131.
- Check 4-IC133 ($\overline{\text{WE}}$), 4-IC134, 4-IC135, 4-IC136, 47-IC101.
- Check 5-IC133 ($\overline{\text{RAS}}$), 5-IC134, 4-IC135, 4-IC136, 43-IC101.

● ERR 211 (bank 2)

- Check 6-IC121 (CAS), 16-IC136, 11-12-13-IC111, 1-2-3-IC111, 7-IC149

5.2 ERR 212. Incorrect memory mapper

During ERR 212 the programme executes the following instructions continuously.

Write 00 and FF to port address FC and read port address FC. In that case the signal forms are:

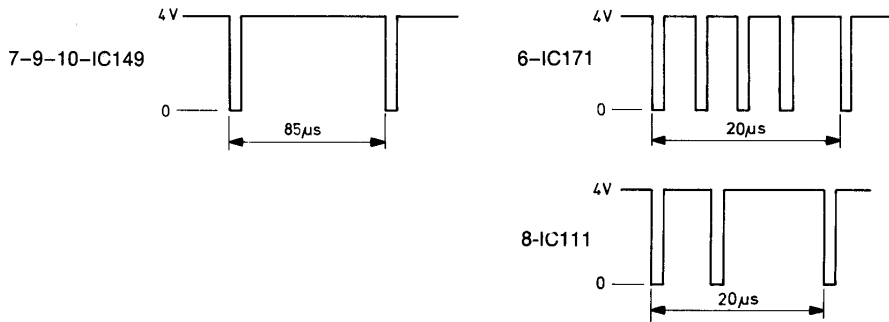

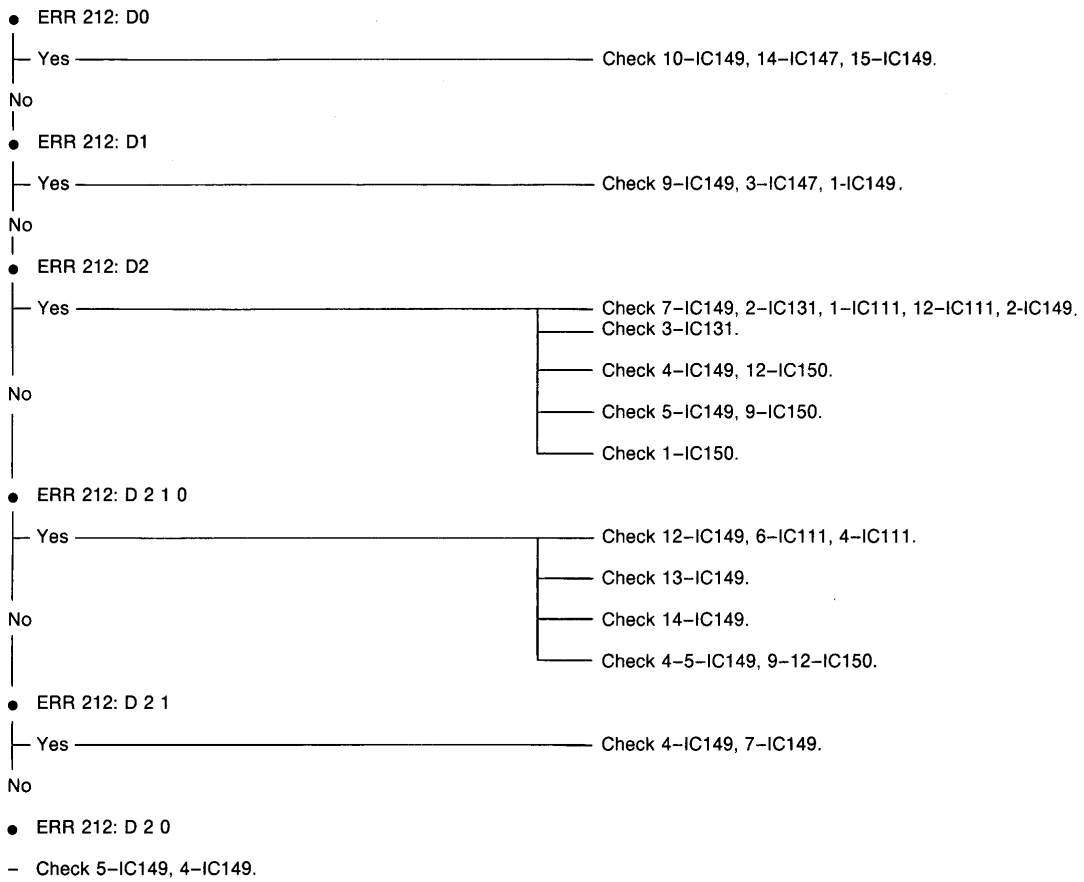

5.3 ERR 215. Incorrect address selection

During ERR 215 the programme continuously writes the value of the accumulator to memory location C000. In that case the various signal forms are:

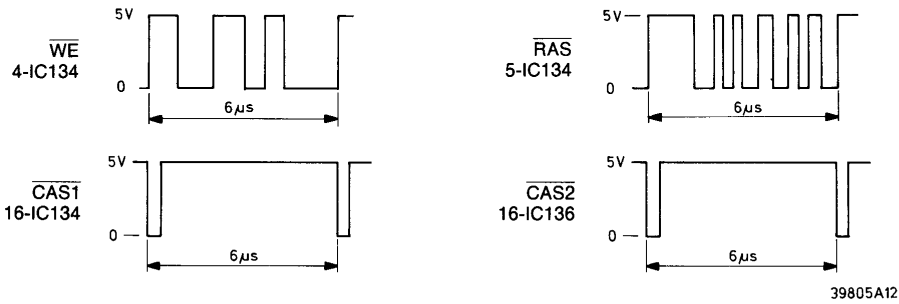

During ERR 215 $\overline{\text{RSEL}}$ (8-IC115) is high.

- ERR 215: (bank 1)
 - Check 4-IC133 (WE).
 - Check 5-IC133 (RAS).
 - Check 16-IC133 (CAS).
 - Check 4-IC134 (WE).
 - Check 5-IC134 (RAS).
 - Check 16-IC134 (CAS).
 - Check 2-3-15-17-IC133.
 - Check 2-3-15-17-IC134.
- ERR 215: (bank 2)
 - Check 4-IC135 (WE).
 - Check 5-IC135 (RAS).
 - Check 16-IC135 (CAS2).
 - Check 4-IC136 (WE).
 - Check 5-IC136 (RAS).
 - Check 16-IC136 (CAS2).
 - Check 2-3-15-17-IC135.
 - Check 2-3-15-17-IC136.

5.4 ERR 221. Open data line(s)

During ERR 221 the programme continuously writes the contents of the accumulator to memory location C000.

n = incorrect data line(s)

- ERR 221 : Dn (bank 1)
 - Check the indicated data line(s) on IC134 (for D0-D3) or IC133 (for D4-D7).
- ERR 221 : Dn (bank 2)
 - Check the indicated data line(s) on IC136 (for D0-D3) or IC135 (for D4-D7).

5.5 ERR 241. Incorrect slot selection

During ERR 241 00 and FF are written to port A8 (slot selection register).

- ERR 241
 - Check 8-IC115, 9-IC101.
 - Check 4-IC127, 8-IC123, 5-10-IC111.
 - Check 9-IC128, 3-IC155, 3-IC153.
 - Check 10-IC101 (A15).
 - Check 11-IC101 (A14).

5.6 ERR 261. Incorrect RAM CHIP

It is being tried to make all 8 bits of a byte (for the total 64k) high. If this is not possible, error message 261 is given with the incorrect data bit(s).

During ERR 261 the contents of the accumulator is continuously written to memory location C000. In this case the signal form is (see ERR 211 for possible other signal forms to be checked):

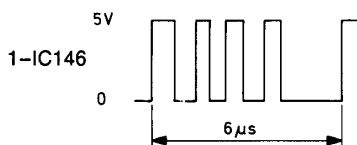

39809A12

n = incorrect data bit(s)

- ERR 261: D 6 5 4 3 2 1

Yes ————— Check 1-IC146, 1-IC147, 44-IC101.
 ————— Check 6-8-4-5-9-10-IC111.

No

- ERR 261: Dn (other possibilities)

— Check 5-IC132, 4-IC132, 28-IC145.

5.6 ERR 271. Incorrect address line(s)

ERR 271 is given with an open or short-circuited address line (address lines A0 through A7 only). During ERR 271 the contents of the accumulator is written to memory locations C000 and FFFF.

n = incorrect address line

ERR 271 (bank 1)

- ERR 271 : A 7 6 5 4 3 2 1 0

Yes ————— Check 44-IC101 (MUX), 1-IC146, 1-IC147.

No

- ERR 271 : A 7 6 1 0

Yes ————— Check 1-IC147.

No

- ERR 271 : A 5 4 3 2

Yes ————— Check 1-IC146.

No

- ERR 271 : An (other possibilities)

— Check the indicated address line(s) on IC133, IC134, IC146 and IC147
 — Check 9-IC151, 5-6-3-4-IC157, 8-9-10-11-IC157

ERR 271 (bank 2)

- ERR 271 : An

— Check the indicated address line(s) on IC135 and IC136.

5.7 ERR 281. Refresh error

ERR 281 occurs in case of a refresh error and when one of the higher address lines (A8–A15) are open on IC146 and IC147.

During ERR 281 the following instructions are executed continuously: – Write 55H to 8000.
– Read 8000.

- ERR 281 (bank 1)
 - Check 2–IC111, 13–IC111, 6–IC121, 11–IC111.
 - Check 10–IC146.
 - Check 10–IC150 (A14 open).
 - Check 3–IC147.
 - Check 13–IC150 (A15 open).
 - Check 13–IC146 (A12 open).
 - Check 10–IC146 (A13 open).
 - Check 10–IC147 (A8 open).
 - Check 13–IC147 (A9 open).
 - Check 6–IC146 (A10 open).
 - Check 3–IC146 (A11 open).
 - IC133 defective.
 - IC134 defective.
 - Check 3–5–IC151, 11–12–13–IC180.
- ERR 281 (bank 2)
 - Check 13–IC111.
 - IC135 defective.
 - IC136 defective.

6. CASSETTE TEST <F3>

With the cassette test the cassette interface and the recorder can be tested.
The possibilities are:

1. Writing a byte (55 hex)

First a header is sent out (for about 10 seconds).
Hereafter 256 (FF hex) bytes are sent out or the bytes are sent out continuously.
While bytes are being sent out to the recorder it is possible to trace the signal path from the computer to the recorder (from 2-IC101 to 4-MD).

2. Writing the header

The header is sent out continuously. It is possible to trace the signal path from the computer to the recorder (from 2-IC101 to 4-MD).

3. Reading tape

While reading bytes it is possible to trace the signal path from the recorder to the computer (5-MD to 1-IC101).
The header has the following form:

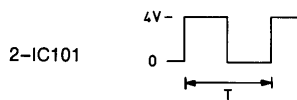

1200 baud: $T = 0.4$ ms

2400 baud: $T = 0.2$ ms.

A byte which is sent out to the recorder begins with a start bit (logical 0) and ends with two stop bits (logical 1).

Then the byte (55 hex = 01010101 bin) has the following form:

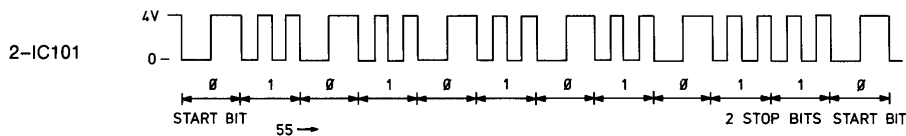

1200 baud: 0 = 1200 Hz

1 = 2400 Hz

2400 baud: 0 = 2400 Hz

1 = 4800 Hz

38 015 A12

The following error messages may occur:

- ERR 301: Header not read correctly (no time-out but too many errors).
- ERR 311: Data cannot be read.
- ERR 312: Data not read correctly: first byte is not correct.

7. SOUND TEST <F4>

The registers in the sound generator (integrated in the S-3527) are tested by the sound test. The screen displays which sound signal is generated at that moment.

The various noises are:

Channel A - increasing amplitude on channel A
 Channel B - decreasing amplitude on channel B
 Channel C - increasing amplitude on channel C
 Channels A,B,C - successive increase of the amplitudes of channels A, B and C. After that the amplitudes remain high.

Noise A - increasing amplitude on channel A
 Noise B - constant amplitude on channel B
 Noise C - constant amplitude on channel C

Envelope 1 - enveloping signal form on channel A
 Envelope 2 - enveloping signal form on channel A having a higher frequency than envelope 1

7.1 ERR 400. Incorrect reading

ERR 400 occurs when the registers of the sound generator in the S-3527 (IC101) are defective.

7.2 Other sound problems

- Check if the sound of the sound test corresponds with the message on the screen.

- Absolutely no sound.

Yes _____ No _____	Check 5-IC101, Q321 for SCART Q322 for AUDIO OUT and RF modulator. Limited sound - IC101 defective.
-----------------------	---

8. I/O TEST <F5>

This test can be used to check parts of IC101 for correct functioning.

During the I/O test pulses are generated on CMO, REM, PPISND, CAPS (2-3-4-64-IC101), CS2 (85-IC101) and ROMCS, CS1, CS2, SLTSL1, SLTSL2 (42-84-86-87-88-IC101).

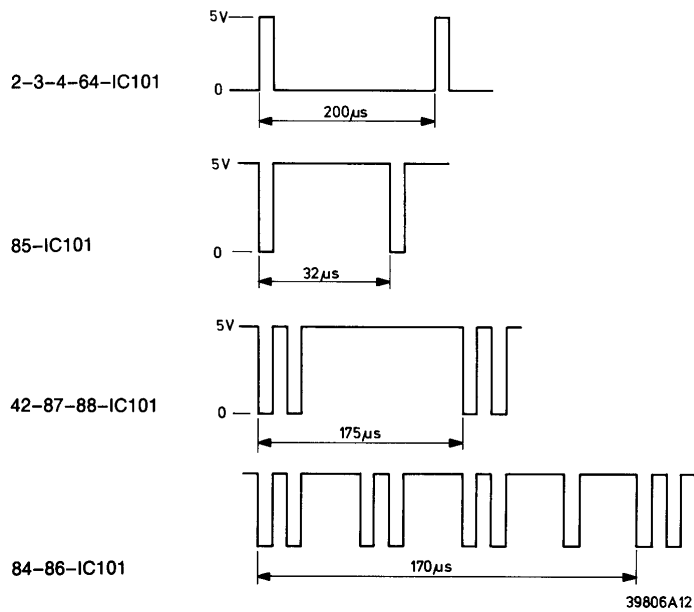

9. PATTERN TEST <INS>

With the pattern test the various functions of the video processor can be checked, such as:

- Character set in 40 character mode.
- Character set in 80 character mode.
- Colour possibilities in high resolution mode (mode 7).
- Bar pattern.
- Sprite test.

It is also possible to check the video RAM with the pattern test.

9.1 Character set mode 40 <F1>

The character set is represented in the 40 characters/line mode. From some characters from the first three lines some pixels are missing at the right-hand side of the character (the first three lines contain the special graphical characters).

Display of the characters can be used for a visual check of the 40 character mode.

9.2 Character mode 80 <F2>

The character set is represented in the 80 characters/line mode.

From some characters from the first three lines some pixels are missing at the right-hand side of the character (the first two lines contain the special graphical characters).

Display of the character set can be used for a visual check of the 80 character mode.

9.3 Colour stripes <F3>

The 256 colours that are possible in screen mode 7, are represented here.

9.4 Bar pattern <F4>

A bar pattern of 15 colours is generated. With the signal forms of the RGB output of the VDP (23-22-24-IC106) the analog circuit can be checked.

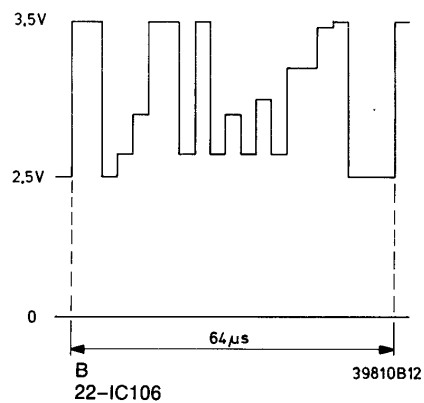
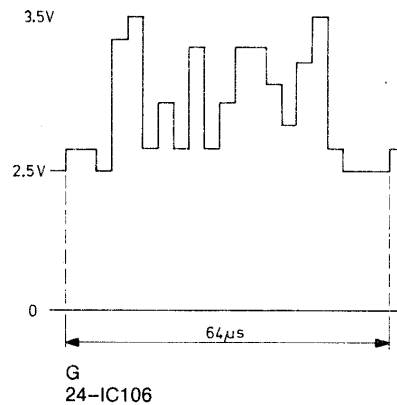
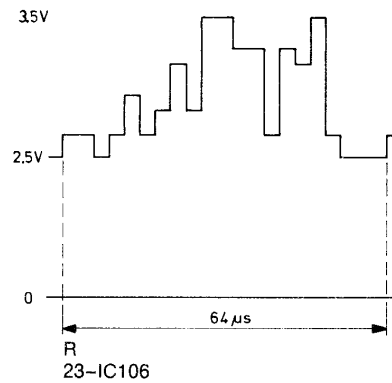

9.5 Sprite test <F5>

The sprite test produces 9 sprites on the screen (figures 0 – 8).

The sprites are tested for collision and the possibility to represent 8 sprites in a row.

With sprite errors the colour of the screen border changes.

- Green border : The 9 sprites are placed obliquely above each other. The coincidence flag may not be set now; if this is the case, the screen will turn green.
- Red border : The sprites placed obliquely above each other are slid together. If the coincidence flag has not been set now, the screen will turn red.
- Yellow border : The 9 sprites are placed next to each other (the 9th sprite is not visible now). If the 9th sprite flag has not been set now, the screen will turn yellow.
- Purple border : The screen turns purple when the 9th sprite flag has been set while there are not less than nine sprites in one row.

In all these cases the VDP will be defective (IC106).

9.6 Video RAM test (one-time <TAB> or continuous <ESC>)

The video memory of the NMS8250 consists of 128k RAM (subdivided into two banks of 64k).

During start-up of the test programme the first 16k from bank 1 are tested. Errors in the first 16k are indicated by means of a colour indication. Errors in the other 112k are indicated by means of an error message. Because of the test method applied the test colour pattern appears on the screen during the video RAM.

9.6.1 ERR 615. Incorrect address selection

- ERR 615 (Bank 2)
 - Check 4-IC104 (WE).
 - Check 4-IC105 (WE).
 - Check 5-IC104 (RAS).
 - Check 5-IC105 (RAS).
 - Check 16-IC104 (CAS).
 - Check 16-IC105 (CAS).

9.6.2 ERR 621. Open data line(s) (Bank 2)

n = incorrect data line(s)

- ERR 621 : Dn
 - Check incorrect data line(s) on IC104 and IC105.

9.6.3 ERR 671. Incorrect address lines (Bank 2)

n = incorrect address lines

- ERR 671 : An
 - Check address lines on IC104 and IC105.

9.6.4 ERR 681. Refresh error

- ERR 681 (Bank 1)
 - Check IC102 and IC103.
- ERR 681 (Bank 2)
 - Check IC104 and IC105.

**10. SUM CHECK TEST **

The ROMs applied in the NMS8250 and the test cartridge can be checked with the sum check test. The result of the sum check (addition of bytes) is placed behind the name of the ROM to be checked on the screen.

10.1 Sum check test ROM <F1>

- Sum check result is D41F (new version 090187)

- Yes _____ test ROM is good.
- No _____ test ROM is defective.

10.2 Sum check BASIC ROM <F2>

Before the sum check test is determined, the BASIC ROM (8) has to be switched on with test switch.

- Sum check result is: 8223 (/00)
8F2E (/16)
6EF7 (/19)

- Yes _____ IC119 is good
- No _____ Select I/O test <F5> for pulses on 20-22-IC119.
_____ Check 20-22-IC119.
_____ IC119 defective.

10.3 Sum check expansion ROM <F3>

Before the sum check is determined, the expansion ROM has to be switched on with test switch.

- Sum check result is: CF9D (/00)
0748 (/16)
CBFF (/19)

- Yes _____ IC118 is good.
- No _____ Check 20-IC118.
_____ Check 22-IC118, 89-IC101.
_____ IC118 defective.

10.4 Sum check disk ROM <F4>

- Sum check result is: 293E
2788 (fast version)

- Yes _____ IC117 is good.
- No _____ Check 20-IC117, 84-IC101, 3-IC153, IC126, IC128.
_____ Check 22-IC117, 27-IC101.
_____ IC117 is defective.

11. RTC TEST <CODE>

The RTC (Real Time Clock) has apart from a date and time function also a memory function (26x4 bit RAM). With the RTC test these functions are tested. If during start-up of the test programme an RTC error is detected, the RTC test is selected automatically. (The period time of the signal forms in case of an error will then be 30us instead of 58us).

In case of an RTC error the following instructions are executed continuously:

- Write 00 to port address B4.
- Write 00 to port address B5.
- Read port address B5.
- Write FF to port address B4.
- Write FF to port address B5.
- Read port address B5.

In this case the signal forms are:

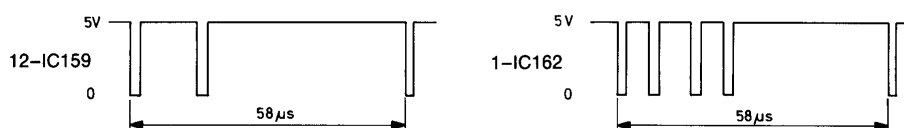

39808A12

11.1 ERR 711. RTC RAM not available

- ERR 711
 - Check 1-IC162, 11-IC159, 1-2-3-IC127, 13-14-15-IC159, 11-12-13-IC175, 4-5-6-IC127.
 - Check 12-IC159, 7-IC172, 5-IC159, 9-IC171.
 - Check 10-IC162.
 - Check 11-12-13-14-IC172, 11-12-13-14-IC162.
 - Check 3-4-5-6-IC172, 4-5-6-7-IC162, 11-12-13-14-IC162, 3-4-5-6-IC161, 8-9-10-11-IC161.

11.2 ERR 715. Incorrect mode selection

- ERR 715
 - Check 10-IC162.

11.3 ERR 721. Incorrect data line(s)

n = incorrect data line(s)

- ERR 721 : Dn
 - Check incorrect data line(s) on IC162.
 - Check 12-IC159.

11.4 ERR 771. Incorrect address line(s)

n = incorrect address line(s)

- ERR 771 : A 3 2 1 0

Yes ————— Check 5-IC162, 5-IC161, 9-IC161.

No

- ERR 771 : An
 - Check indicated RTC address line(s) on IC162, IC172 and IC161.

11.5 ERR 799. Incorrect time function

- ERR 799
 - Check 16-17-IC162, X102.

12. PRINTER TEST <ESC>

The printer asks for a character. If this character is not printed within 5 seconds, an error message is displayed. If the character is printed, the programme asks for that character.

If the printed character does not correspond with the character given, the wrong bit lines are indicated.

By entering the characters * (shift 8) and U (shift u) all bit lines except bit line 7 are tested. The printer test uses the character table from the BASIC ROM (IC119). The BASIC ROM is switched on with SW101.

n = incorrect line(s)

12.1 ERR 801. Bit(s) n

- ERR 801
 - Check indicated bit line(s) on IC101.
 - Check the connection between computer and printer.
 - Defect in printer.

12.2 ERR 810. No communication computer–printer

- ERR 810
 - Check if the printer is connected.
 - Check 100–IC101.
 - Check 91–IC101.

13. ERR 990. INCORRECT INTERRUPT SIGNAL

This error message is given when the duration of the interrupt signal deviates from 20 ± 2 ms.

- ERR 990
 - Check 16–IC145, 5–6–IC110.
 - Check 8–9–12–13–IC125, 25–IC106.
 - Check 24–IC145, 41–IC101.
 - Check 6–7–IC156, 27–IC145.

14. ERR 999. NO INTERRUPT SIGNAL FROM VDP

This error message occurs when the interrupt signal is continuously low.

- ERR 999
- Check 16-IC145, 5-6-IC110, 8-12-IC125, 25-IC106.

15. FLOPPY DISK DRIVE INTERFACE TEST

This test cartridge does not provide the tests of the floppy disk drive interface, this requires the FDD test cartridge (floppy disk drive).

This cartridge with associated description is available under service code number 4822 397 30135.

The error messages mentioned in this chapter have occurred in the floppy disk drive interface section.

The same error message may also be caused by an error in the floppy disk drive. First it should thus be determined if the error occurs in the floppy disk drive or in the floppy disk drive interface (by exchanging the floppy disk drive).

If the error occurs in the floppy disk drive, reference is made to Service Manual NMS8250.

Below follows an enumeration of the error messages that may occur and with the possible causes.

- ERR 001. Disk off line
 - Check 27-IC153, 2-1-IC163, 5-6-IC140.
 - Check 34-IC153, 6-5-IC163, 2-1-IC140.
 - Check 15-IC153, 11-12-13-IC154.
 - Check 1-2-3-IC164, 16-IC153.
 - Check 8-9-10-IC142, IC139, 4-5-6-IC124, 1-2-3-IC137
 - Check 126-IC128
- ERR 101. Track 00 error 1
 - Check 34-153, 5-6-IC163, 1-2-IC140.
- ERR 104. Track error
 - Check IC153
- ERR 106. Write protect error 1
 - Check write protect slide on the disk (should be open).
 - Check IC153, 3-4-IC163, 34-IC140.
- ERR 110. Track 00 error 2
 - Check 34-153, 3-4-IC163, 1-2-IC140.
- ERR 111. Track 00 error 3
 - Check 34-IC153, 5-6-IC163, 1-2-IC140.
- ERR 201. Track 00 error 1
 - Check 34-IC153, 5-6-IC163, 1-2-IC140.
- ERR 204. Track error
 - Check IC153.
- ERR 206. Write protect error 2
 - Check write protect slide (should be closed).
 - Check 36-153, 3-4-IC163, 3-4-IC140.

- ERR 210. Track 00 error 2
 - Check 34-IC153, 5-6-IC163, 1-2-IC140.
- ERR 211. Track 00 error 3
 - Check 34-153, 5-6-IC163, 1-2-IC140.
- ERR 300. Busy error
 - Check IC153.
- ERR 301. Index error
 - Check 35-IC153, 10-11-IC163, 12-13-IC140.
- ERR 303. CRC error
 - Check IC153.
- ERR 304. Seek error
 - Check IC153.
- ERR 305. Write error
 - Check 39-153, 1-2-IC110, 1-4-5-IC148.
 - Check 3-4-IC110, 1-2-3-IC148, 38-IC153.
 - Check IC153, 8-9-10-IC164.
 - Check IC153, 4-5-6-IC164.
- ERR 306. Write protect error 3
 - Check 36-IC153, 4-3-IC163, 4-3-IC140.
- ERR 307. Disk not ready.
 - Check 32-IC153, 4-3-IC163, 4-3-IC140.
- ERR 308. Wrong side
 - Check 8-9-10-IC142, IC152-1, 4-5-6-IC142, IC126.
- ERR 400. FDC Busy error
 - Check IC153.
- ERR 401. Data request error
 - Check 38-IC153, 3-4-IC110, 1-2-3-IC148, 8-9-10-IC124 U5.
- ERR 402. Lost data
 - Check 38-IC153, 3-4-IC110, 8-9-10-IC124, 1-2-3-IC148 U5.
- ERR 403. CRC error 2
 - Check IC153.U7.
- ERR 404. Record not found
 - Check 4-5-6-IC164, 31-IC153.
- ERR 405. Record type error
 - Check IC153.
- ERR 407. FDC not ready.
 - Check IC153.
- ERR 500. Media type error
 - Check IC153.
- ERR 501. Sector error
 - Check IC153.

- ERR 503. Drive data error
 - Check IC153.
- ERR 504. Track data error
 - Check IC153.
- ERR 505. Sector data error
 - Check IC153.
- ERR 506. Wrong data error
 - Check IC153.

- **Bus errors**

Try to detect the incorrect bus line (address bus line, data bus line or control bus line) in case of a bus error (black screen) by means of an oscilloscope. Then the ICs connected to the incorrect bus line have to be checked.

Another possibility to detect an incorrect bus line is to switch the computer to the reset mode (tristate mode). Then it will be possible to detect the incorrect bus line by means of a voltmeter.

Note:

In case of problems with cartridges connected to the computer the output/input buffers: IC-165, IC-170, IC-169, IC-168, IC-167, IC-166 may cause incorrect functioning.