

PowerCenter™ Certification Module

PowerCenter Minitower 132/150/166/180



Table of Contents

PowerCenter™ NT Specifications

Specifications for the PowerCenter NT 132/150/166/180	Page 2
MLB Diagram	Page 5

CUDA Reset

For Your Safety	Page 3
Purpose of CUDA Reset.....	Page 4

Bezel Removal/Installation

Removing and installing the chassis cover.....	Page 6
Removing and installing the front bezel.....	Page 7

Board Removal/Installation Procedures

Removing and installing RAM	Page 9
Removing and installing VRAM.....	Page 11
Removing and installing CPU card.....	Page 13
Removing and installing L2 cache	Page 15
Removing and installing PCI expansion cards.....	Page 16
Removing and installing PCI Riser card.....	Page 19

Drive Removal/Installation Procedures

Removing and installing drives in the 3.5-inch drive bay.....	Page 21
Removing and installing drives in the 5.25-inch drive bay.....	Page 22
Removing and installing the floppy disk drive	Page 24

System Level Removal/Installation Procedures

Removing and installing the MLB.....	Page 26
Removing and installing the power supply	Page 29

PowerCenter NT Specifications

CPU	PowerPC 604 at 132, 150, 166 or 180MHz
Main Logic Board	Catalyst (Comparable to a Macintosh 7200)
CPU Upgrade	Available via daughtercard replacement
MacOS	7.5.2, 7.5.3, 7.5.5, 7.6, 7.6.1
Memory	4 DIMM slots—168-pin, 64 bit, 70 ns (512 Mb max); Memory interleaving not supported
Cache	512 KB Level 2
SCSI	SCSI-2; 5 MB/sec data transfer rate
Serial Ports	High speed GeoPort-compatible 9-pin modem and printer ports
Network	Built-in Ethernet AAUI port; Built-in Ethernet 10 Base-T port; LocalTalk serial connection via modem or printer port
Bus Expansion	Three PCI expansion slots
Floppy Drive	One 3.5-inch, 1.4MB floppy disk drive. Supports MacOS, Windows, DOS, OS/2 and ProDOS disk formats.
Video	Internal video with both Mac and SVGA connections 1MB VRAM built-in and upgradeable to 4MB max Optional high-quality accelerated video cards
Audio	16 bit, 44.1 KHz Stereo in/out connections (microphone port requires line-level input, such as Apple's Plaintalk Microphone); Built-in speaker
ROM	Removeable Apple ROM
Case style	Mini-tower
Drive Bays	Three front accessible, full-height 5.25-inch drive bay; one internal 3.5-inch full height drive bay
Dimensions	7"(W) X 15"(H) X 16"(D); 22 lb (10.5 kg)
Power Supply	200W, 100V-240V (Domestic/International manual switching)



For Your Safety

To ensure your personal safety as well as prevent unnecessary damage to the computer, please follow all safety precautions when performing any service on Power Computing computers.

Note: Always make sure that the computer is powered down before attempting any service. To make sure that the computer is completely powered down, check the light behind the power button on the front bezel and make sure that it is off.

Preventing ESD (Electrostatic Discharge) - There are two means by which a technician can maintain a ground and eliminate ESD:

- wear an ESD wrist strap that is grounded to the computer
- power down the computer, but leave the CPU power cord plugged into the wall socket; touch the metal case of the power supply to ensure complete static discharge before service.

Do not wear loose clothing or jewelry that may become caught in the components inside of the computer case.

Make sure that the work environment is free from excessive moisture. Any moisture on the components of the computer may cause damage.

If you need further assistance, please call:

1-800-708-6227



CUDA Reset

The CUDA Reset button is a small red button located on the Main Logic Board. Depressing this button resets the CUDA Microcontroller Chip. This chip is responsible for the following functions:

- Turns system power on and off
- Manages system resets from various commands
- Maintains parameter RAM
- Manages the Apple Desktop Bus (ADB)
- Manages the real-time clock
- Lets an external signal from either Apple GeoPort serial port control system power

It is rarely necessary to reset CUDA, but many problems that appear to be hardware related can be fixed by doing so. Resetting CUDA will not harm the machine in any way. Some of the most common reasons to reset CUDA are:

- After adding RAM, the machine will not boot, RAM does not show up in the memory control panel, etc.
- Machine will not power up
- Machine powers up, but does not chime or boot
- A serial port remains inaccessible even after booting without extensions, resetting parameter RAM, etc.
- Machine will power down for no apparent reason
- After adding any hardware to the inside of the machine

Resetting CUDA

1. Shut down the computer and disconnect all external devices, but leave the power cable plugged in to ground the computer.
2. Remove the cover (refer to ***Chassis Cover Removal/Installation*** on page 6).
3. Touch the metal chassis of the machine. This will dissipate static electricity into ground.
4. Locate the CUDA Reset button (refer to ***MLB Diagram*** on page 5).
5. Press the CUDA Reset button for a few seconds.
6. Reboot, and verify resolution of the problem you wanted to solve.

Note: Resetting the CUDA will cause some system settings to default to factory settings.



MLB DIAGRAM

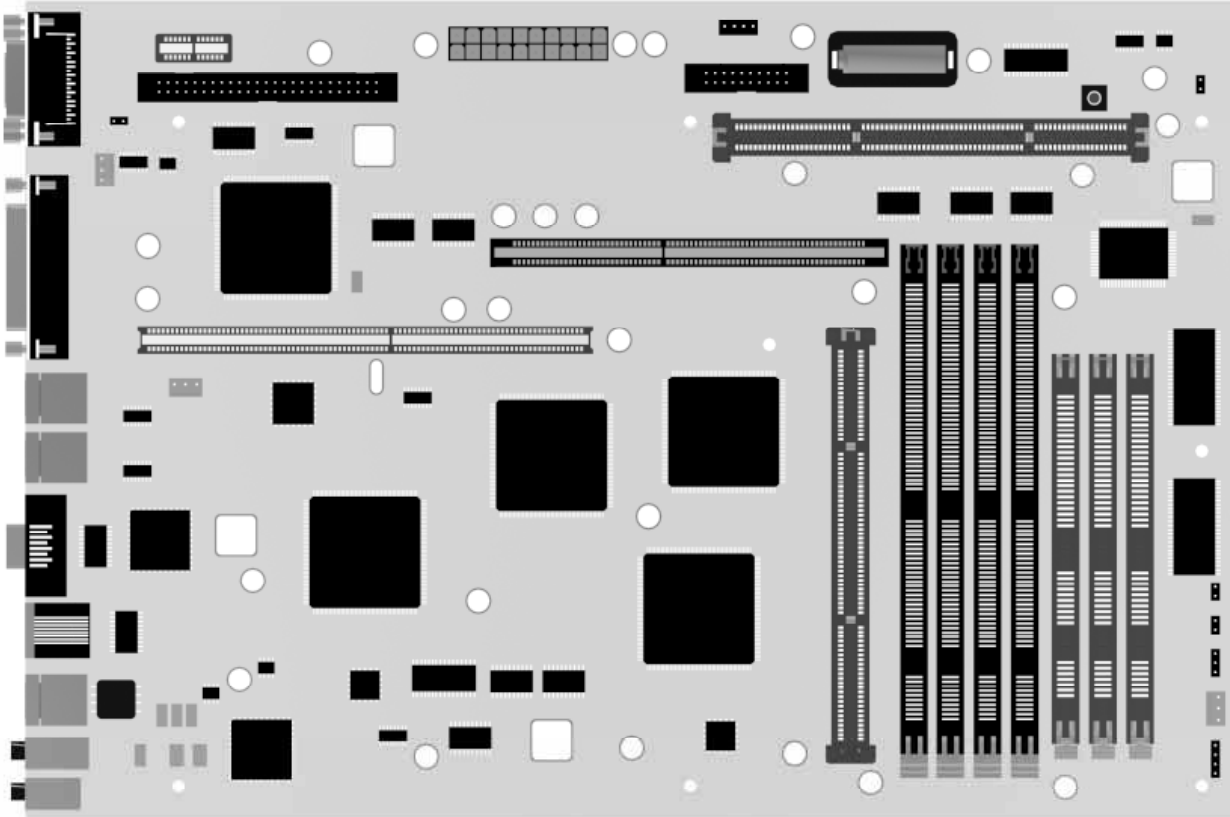



Chassis Cover Removal/Installation

Removing the Chassis Cover

1. Shut down the computer and turn off all external devices. If you do not have a grounding strap, leave the computer plugged into the wall socket. Leaving the computer plugged in ensures a positive ground. Disconnect everything but the power cord.
2. Remove the four thumb screws from the rear of the computer.
3. Push the cover back and away from the machine chassis. Lift the cover up and remove from the chassis.

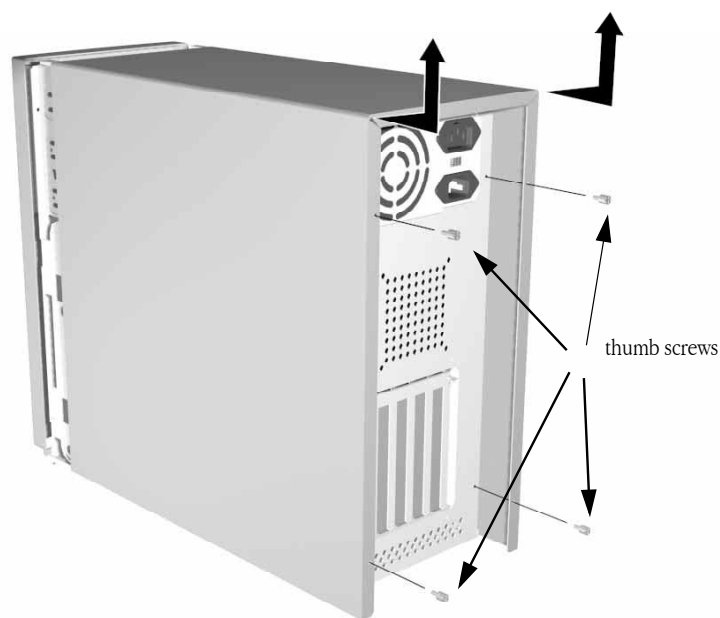

Figure 1: Removing the chassis cover

Installing the Chassis Cover

1. With the computer upright, place the cover over the chassis. Push the cover towards the front of the chassis. The front lip of the cover will engage the chassis frame.
2. Replace the four thumb screws from the rear of the computer.
3. Reconnect the cables to the machine.



Front Bezel Removal/Installation

Removing the Front Bezel Cover

1. Remove the chassis cover (refer to **Chassis Cover Removal/Installation** on page 6).
1. Remove the main logic board protector plate on the closed side of the chassis by removing the four securing screws and placing the plate aside.
2. Remove the six screws that secure the bezel to the front of the computer (see **Figure 2: Removing protective plate** on page 7). All of these screws must be removed before the front bezel can be removed. The screws are located on the inside of the chassis frame:
 - one is on the top left end of the chassis
 - one is in the left middle of the chassis
 - one is on the bottom left end of the chassis
 - one is on the top right end of the chassis
 - one is in the right middle of the chassis
 - one is on the bottom right end of the chassis

Gently pull the bezel directly forward to disengage. Lay the bezel face down directly in front of the chassis.

3. Disengage the wiring between the chassis and the front bezel.

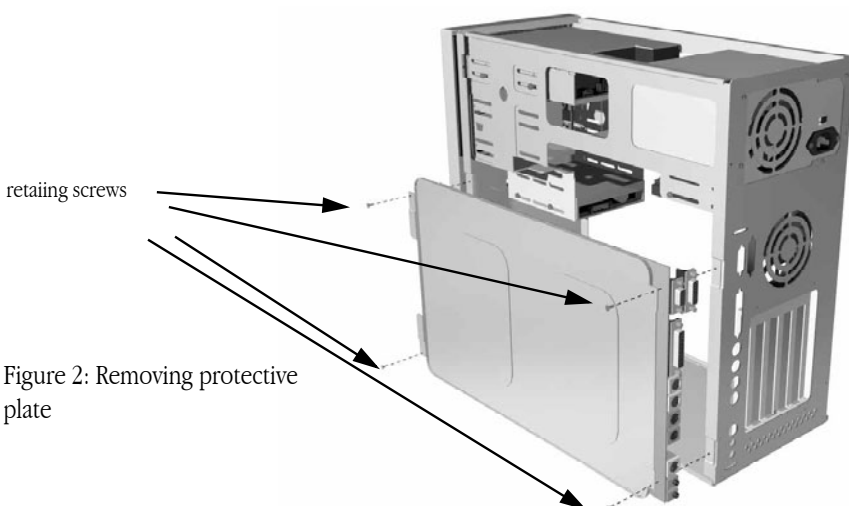

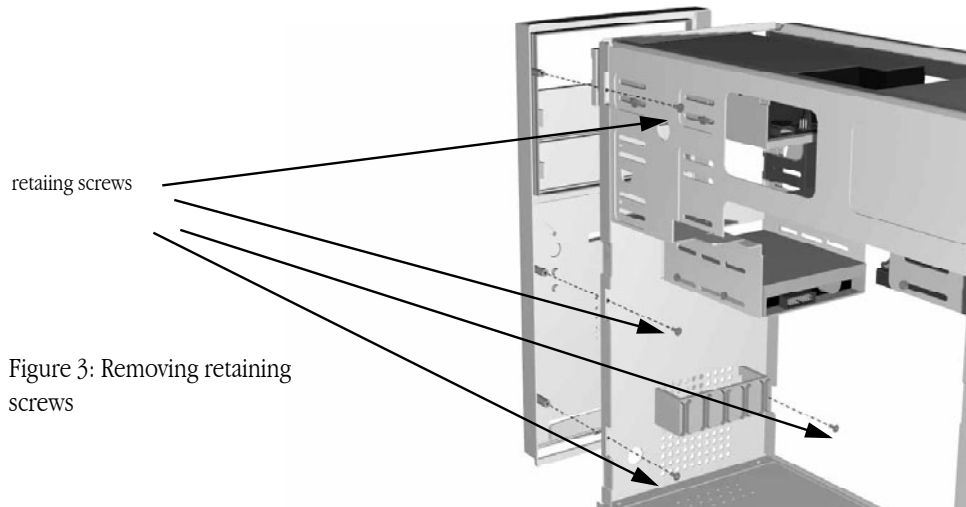

Figure 3: Removing retaining screws

Installing the Front Bezel

1. Connect the switch and speaker wires to their respective ports on the main logic board.
2. Screw the bezel to the chassis front with the six retaining screws.
3. Replace the MLB protection plate on the closed side of the chassis.
4. Replace the chassis cover (refer to *Chassis Cover Removal/Installation* on page 6).



RAM Removal/Installation

Note: All DIMMs must be 168-pin, fast-paged mode, 70-nanosecond RAM access time or faster. The PowerCenter has four DIMM slots near the front on the motherboard. DIMMs may be installed in any slot.

Removing RAM

1. Remove the chassis cover (refer to *Chassis Cover Removal/Installation* on page 6).
2. Place the unit on its side with the MLB on the bottom and the open side facing up.
3. Locate the DIMM(s) you would like to remove (see *Figure 3:* on page 9). Loosen the desired DIMM module by reaching in and pushing down on the small lever at the end of the DIMM slot. (see *Figure 4: Removing RAM* on page 9). The DIMM should pop loose from the slot at the lever end.

Figure 3:
DIMM slot
location

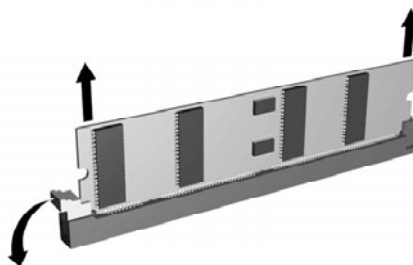
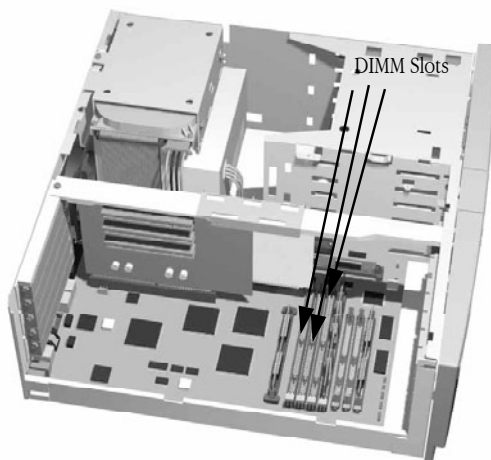

Figure 4: Removing RAM

4. Grasp the DIMM module on each end and evenly pull the module up and out of the slot.

Installing RAM

1. Hold the module (with the contacts down) with one hand at each end. Notice that there are two notches in the contact edge of the DIMM module.
2. Lower the DIMM squarely into the slot so that the notches in the DIMM line up with the notches

in the slot. Slide the contacts straight into the slot and make sure the contacts are firmly seated. (see **Figure 5: Installing RAM** on page 10). When properly seated, the contacts on the bottom should not be visible.

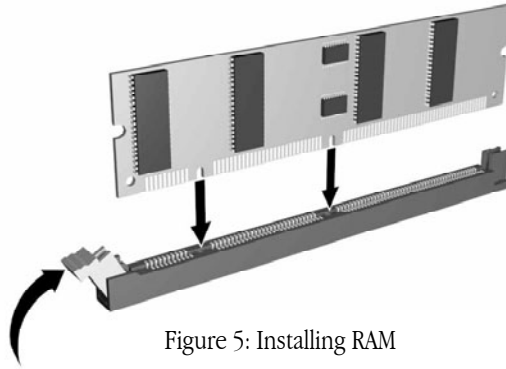

Figure 5: Installing RAM

Note: Don't force the DIMM module into the slot; if the MLB starts bending significantly, pull the DIMM out, reposition it, and try again. If the DIMM module is seated correctly, the lever at the end of the DIMM slot should be completely raised.

3. Reset the CUDA (refer to **CUDA Reset** on page 4).
4. Replace the chassis cover (refer to **Chassis Cover Removal/Installation** on page 6).



VRAM Removal/Installation

Note: All DIMMs must be 112-pin, fast-paged mode, 70-nanosecond access time or faster. The PowerCenter has three VRAM DIMM slots near the front on the motherboard. If one VRAM DIMM is to be installed, it must be installed in the slot closest to the front of the logic board. This gives a total of two megabytes of VRAM. Adding two VRAM DIMMs, providing three megabytes of VRAM, is not a supported configuration. Adding three VRAM DIMMs to give a total of four megabytes of VRAM is the next valid, supported configuration.

Removing VRAM

1. Remove the chassis cover (refer to *Chassis Cover Removal/Installation* on page 6).
2. Place the unit on its side with the MLB on the bottom and the open side facing up.
3. Locate the VRAM DIMM(s) you would like to remove (refer to *MLB Diagram* on page 5). Loosen the desired DIMM module by reaching in and pushing down on the small lever at the end of the DIMM slot. (see *Figure 6* on page 11). The DIMM should pop loose from the slot at the lever end.

Figure 6
VRAM slot
location

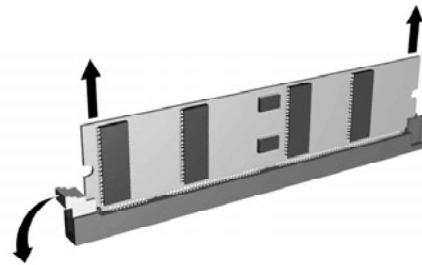
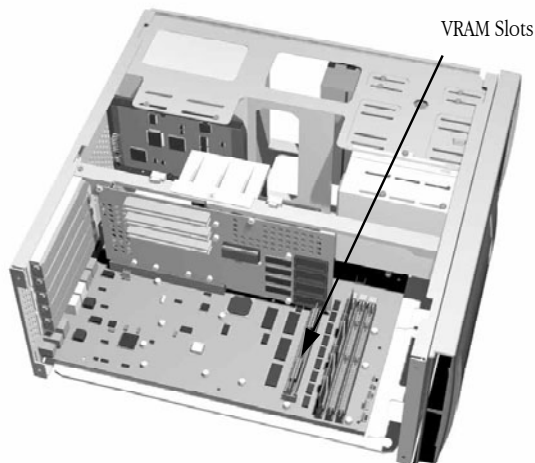

Figure 7: Removing VRAM

4. Grasp the DIMM module on each end and evenly pull the module up and out of the slot.

Installing VRAM

1. Hold the module (with the contacts down) with one hand at each end. Notice that there are two notches in the contact edge of the DIMM module.

2. Lower the DIMM squarely into the slot so that the notches in the DIMM line up with the notches in the slot. Slide the contacts straight into the slot and make sure the contacts are firmly seated. (see **Figure 8: Installing VRAM** on page 12). When properly seated, the contacts on the bottom should not be visible.

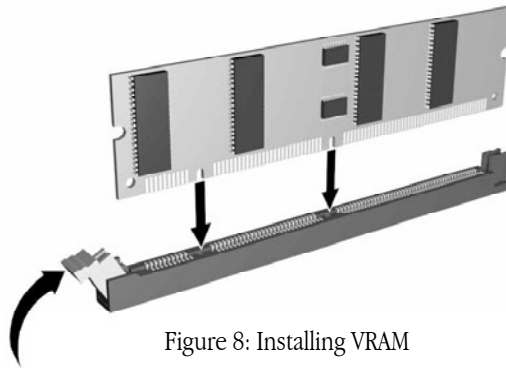

Figure 8: Installing VRAM

Note: Don't force the DIMM module into the slot; if the MLB starts bending significantly, pull the DIMM out, reposition it, and try again. If the DIMM module is seated correctly, the lever at the end of the DIMM slot should be completely raised.

3. Reset the CUDA (refer to **CUDA Reset** on page 4).
4. Replace the chassis cover (refer to **Chassis Cover Removal/Installation** on page 6).



CPU Removal/Installation

Removing the CPU

1. Remove the chassis cover (refer to *Chassis Cover Removal/Installation* on page 6).
2. Place the unit on its side with the MLB on the bottom and the open side facing up.
3. Disconnect the CPU fan from the connector on the main logic board.
4. Remove the fan assembly by sliding the entire assembly forward until it unlocks from the support beam. Lift the assembly out of the machine and set it aside.

Note: The riser arm may be removed if necessary.

5. Place both hands on either side of the CPU card and lift up. Sometimes a gentle rocking motion from end to end (*not side to side*) will make it easier to remove the CPU card.

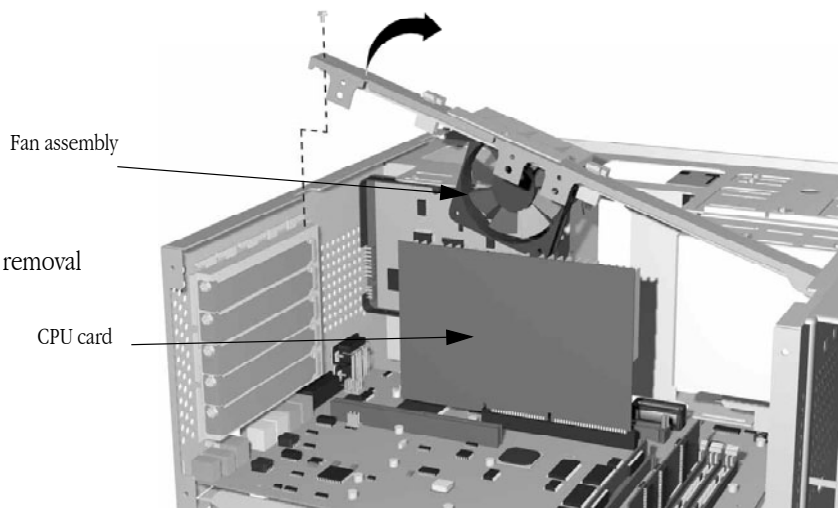

Figure 9: CPU removal

Installing the CPU

1. Hold the CPU card (contacts facing down) with one hand at each end. Notice that there is a notch in the contact edge of the CPU card.

2. Lower the CPU card squarely into the slot so that the notch in the CPU card lines up with the notch in the slot. Slide the contacts straight into the slot and make sure the contacts are firmly seated. (see **Figure 9: CPU removal** on page 13). When properly seated, the contacts on the bottom should not be visible.

Note: Don't force the CPU card into the slot; if the MLB starts bending significantly, pull the CPU card out, reposition it, and try again.

3. Replace the CPU fan assembly by lining up the tab and sliding the entire assembly toward the rear of the chassis.
4. Reconnect the CPU fan to the main logic board. Route the cable so it does not contact the chips on the RAM DIMMs.
5. Reset the CUDA (refer to **CUDA Reset** on page 4).
6. Replace the chassis cover (refer to **Chassis Cover Removal/Installation** on page 6).



Cache Removal/Installation

Removing the Cache

1. Remove the chassis cover. (refer to *Chassis Cover Removal/Installation* on page 6).
2. Place the unit on its side with the MLB on the bottom and the open side facing up.
3. Locate the cache card (refer to *MLB Diagram* on page 5).

Note: The level 2 cache is located between the CPU riser card and the front drive bay assembly. If you believe that the area is too small to adequately grasp the cache card, remove the CPU riser before removing the cache (refer to *CPU Removal/Installation* on page 13).

4. Place both hands on either side of the L2 cache card and lift up. Because the L2 cache is held in by a tight pressure fit, sometimes a gentle rocking motion from end to end (*not side to side*) will make it easier to remove the cache card.

Installing the Cache

1. Hold the L2 cache card (contacts facing down) with one hand at each end. Notice that there are notches in the contact edge of the L2 cache card.
2. Lower the L2 cache card squarely into the slot so that the notches in the L2 cache card line up with the notches in the slot. Slide the contacts straight into the slot and make sure the contacts are firmly seated. When properly seated, the contacts on the bottom should not be visible.

Note: Don't force the L2 cache card into the slot; if the MLB starts bending significantly, pull the L2 cache card out, reposition it, and try again.

4. Reset the CUDA (refer to *CUDA Reset* on page 4).
5. Replace the chassis cover (refer to *Chassis Cover Removal/Installation* on page 6).



PCI Cards Removal/Installation

Note: Before you install any expansion cards, be sure that the combined power consumption of the expansion cards does not exceed the limits of the computer. Refer to the documentation that came with the cards you are installing for their power consumption rating and to “Power requirements” in the *User’s Guide* for the power consumption limit for this computer.

Removing PCI Cards

1. Remove the chassis cover (refer to *Chassis Cover Removal/Installation* on page 6).
2. Place the unit on its side with the MLB on the bottom and the open side facing up.
3. Disconnect any cables that may be attached to the PCI card.
4. Remove the screw attaching the PCI card to the inside of the chassis.
5. Firmly grasp the PCI card and pull it straight out of the computer laterally. Be careful not to damage any components that may be protruding through the I/O slot. Sometimes a gentle rocking motion from end to end (*not side to side*) will make it easier to remove the PCI card.

Installing PCI Cards

1. Remove the chassis cover (refer to *Chassis Cover Removal/Installation* on page 6).
2. Remove the retaining screw of the metal I/O slot cover from the slot you wish to use. (see *Figure 10: Removing PCI slot cover* on page 17).
3. Pull the I/O slot cover out the side so that the tongue at the bottom of the cover slides out of the slot in the chassis.

Figure 10: Removing PCI slot cover

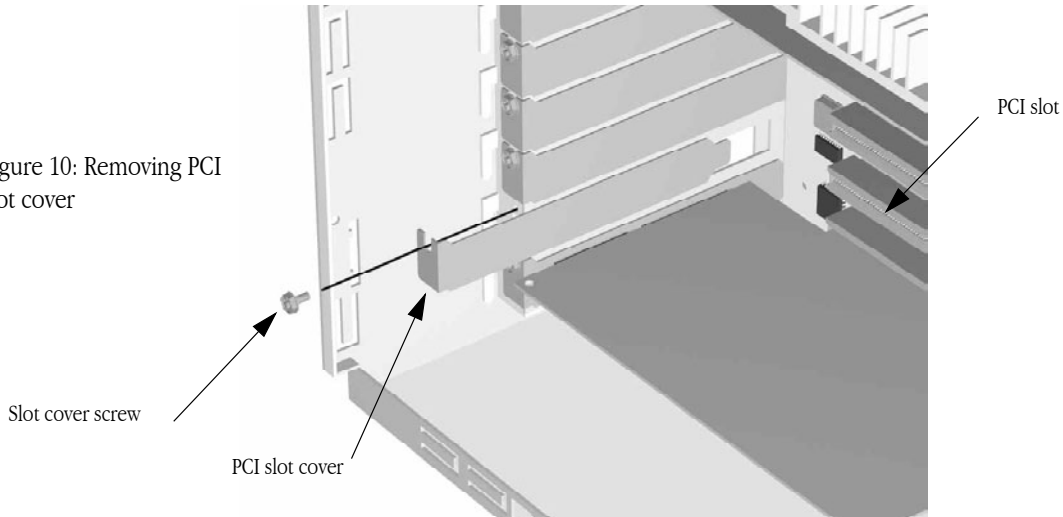

4. Hold the PCI card (contacts facing down) with one hand at each end. Notice that there is a notch in the contact edge of the PCI card.
5. Lower the PCI card squarely into the PCI riser card so that the notch in the PCI card lines up with the notch in the PCI riser card. Slide the contacts straight into the PCI riser card and make sure the contacts are firmly seated. (see **Figure 11: PCI card installation** on page 17). When properly seated, the contacts on the bottom should not be visible. Secure the PCI card to the chassis with the retaining screw.

Figure 11: PCI card installation

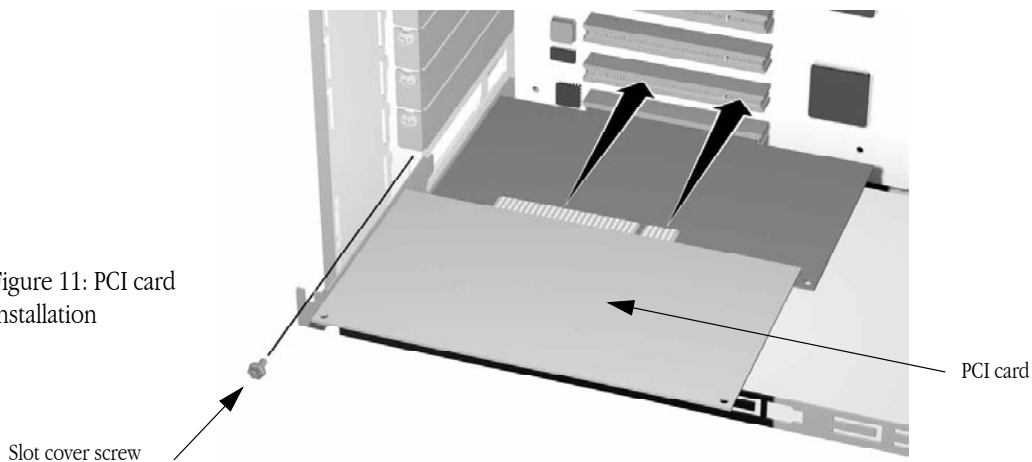

Note: Don't force the PCI card into the slot; if the PCI riser card starts bending significantly, pull the PCI card out, reposition it, and try again.

6. Connect any wires or cables to the PCI card necessary for its proper operation.
7. Reset the CUDA (refer to *CUDA Reset* on page 4).
8. Replace the chassis cover (refer to *Chassis Cover Removal/Installation* on page 6).



PCI Riser Card Removal/Installation

Removing the PCI Riser Card

1. Remove the chassis cover (refer to *Chassis Cover Removal/Installation* on page 6).
2. Locate the riser card (refer to *MLB Diagram* on page 5).
3. Remove any installed PCI cards (refer to *PCI Cards Removal/Installation* on page 16).
4. Remove the two screws that secure the riser card to the crossbar.
5. Disconnect the power cable to the CPU cooling fan.

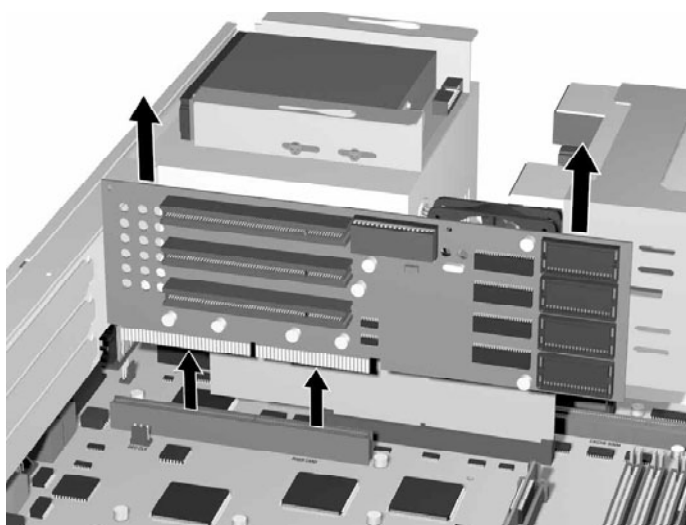

Figure 11:
PCI Riser Card
removal

6. Remove the hex-head screw that secures the support beam to the rear of the chassis. Swing the rear end of the crossbar up, then unhook it from the front of the chassis and remove it from the computer.
7. Firmly grasp the PCI riser card and pull it straight out of the computer. Sometimes a gentle rocking motion from end to end (*not side to side*) will make it easier to remove the PCI card.

Installing the PCI Riser Card

1. Lower the PCI riser card squarely into the PCI slot so that the notch in the PCI card lines up with the notch in the PCI slot. Slide the contacts straight into the PCI slot and make sure the contacts are firmly seated. When properly seated, the contacts on the bottom should not be visible.
2. Replace the support cross beam and its retaining screws.
3. Reconnect the power cable of the CPU cooling fan. Route the cable so it does not contact the chips on the RAM DIMMs.
4. Replace the screws that attach the PCI riser card to the support beam.
5. Reset the CUDA (refer to **CUDA Reset** on page 4).
6. Install the chassis cover (refer to **Chassis Cover Removal/Installation** on page 6).



3.5-inch Drive Removal/Installation

Removing the 3.5-inch Drive

1. Remove the chassis cover (refer to *Chassis Cover Removal/Installation* on page 6).
2. Remove all cables from the drive.
3. Remove the four retaining screws securing the drive to the mounting bracket.
4. Lower the drive out of the bracket straight down and out of the bracket.

Figure 11:
Removing a
3.5-inch

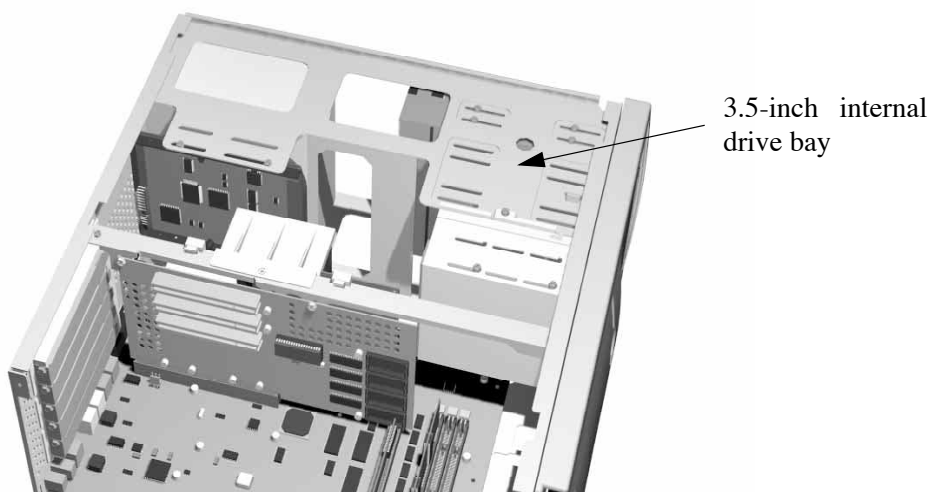

Installing the 3.5-inch Drive

1. Place the drive in the mounting bracket.
2. Secure the drive to the bracket with four retaining screws.
3. Attach all necessary cables to the drive.
4. Remove the chassis cover (refer to *Chassis Cover Removal/Installation* on page 6).
5. Reset the CUDA (refer to *CUDA Reset* on page 4).
6. Install the chassis cover (refer to *Chassis Cover Removal/Installation* on page 6).



5.25-inch Drive Removal/Installation

Removing 5.25-inch Drives

1. Remove the chassis cover (refer to *Chassis Cover Removal/Installation* on page 6).
2. Disconnect all cables that are attached to the device being removed. (see *Figure 12: CDROM Removal* on page 22).

Figure 12: CDROM Removal

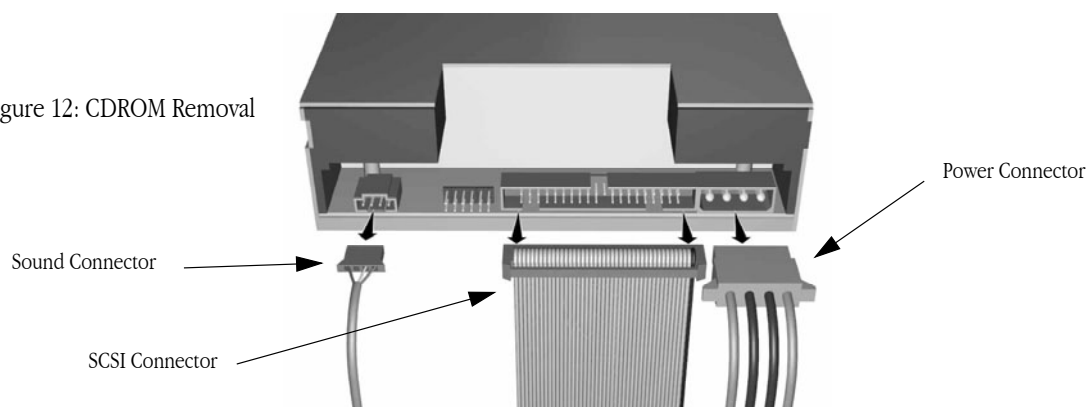

3. Remove the four screws securing the drive to the drive cage
4. Slide the drive forward out of the chassis.

Installing 5.25-inch Drives

1. Slide the drive half way into the front bay location, making sure the cable connections are facing the rear of the computer. Pushing the drive in only halfway makes cable connection easier by giving more maneuvering room behind the drive.
2. Connect the cables to the drive. Slide the drive in the rest of the way, making sure that the drive is flush with the front of the computer.

Figure 13: Faceplate removal

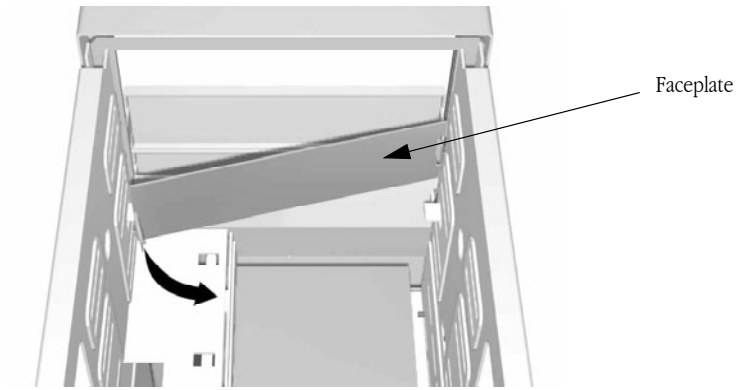
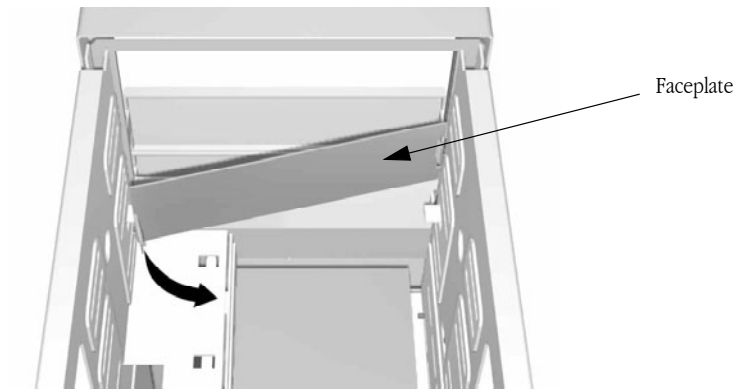

Figure 13: Faceplate removal



3. Replace the screws that secure the drive.
4. Reset the CUDA (refer to **CUDA Reset** on page 4).
5. Install the chassis cover (refer to **Chassis Cover Removal/Installation** on page 6).



Floppy Disk Drive Removal/Installation

Removing the Floppy Disk Drive

1. Remove the chassis cover (refer to *Chassis Cover Removal/Installation* on page 6).
2. Disconnect the cable connected to the floppy disk drive.
3. Remove the two screws that secure the floppy disk drive cage to the 5.25-inch drive cage above it and the front of the chassis.
4. Slide the floppy disk drive cage toward the rear of the computer to unhook it from the 5.25-inch drive cage. Pull the floppy disk drive cage straight out the side of the computer.
5. Remove the four screws that secure the floppy disk device to the mounting cage.
6. Slide the drive out of the mounting cage.

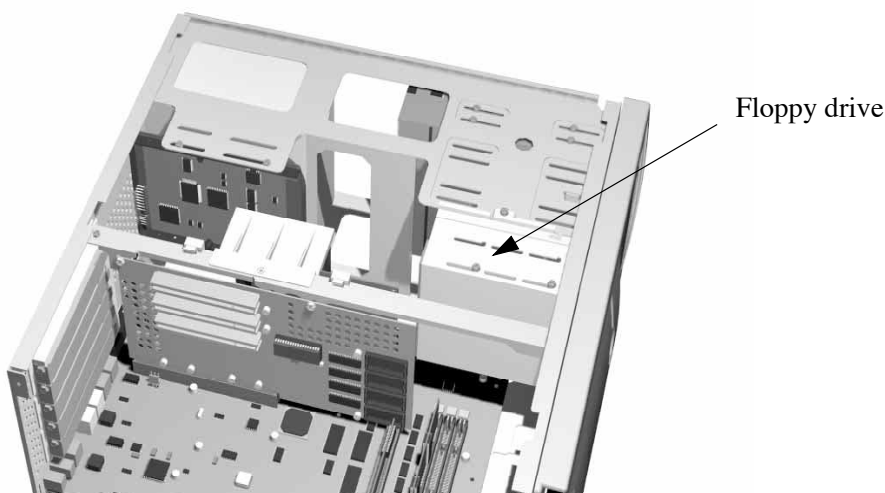

Figure 14:
Removing the floppy
drive bay

Installing the Floppy Disk Drive

1. Slide the drive into the drive cage and line up the drive with the holes on the drive cage.
2. Replace the four screws that secure the drive to the drive cage.
3. Align the tabs on the drive cage with the slots on the bottom of the 5.25-inch drive cage. Slide the floppy disk drive cage forward to hook it in place.

4. Replace the screws that attach the floppy disk drive cage to the 5.25-inch drive cage and the front of the chassis.
5. Reconnect the cable to the floppy disk drive.
6. Reset the CUDA (refer to **CUDA Reset** on page 4).
7. Install the chassis cover (refer to **Chassis Cover Removal/Installation** on page 6).



Removal/Installation of MLB

Removing the MLB (Main Logic Board)

1. Remove the chassis cover (refer to *Chassis Cover Removal/Installation* on page 6).
2. Place the computer on its side with the MLB on the bottom and the open side facing up.
3. Remove the base from the chassis. The base is retained with two screws on the back in the bottom center of the computer and one directly on the bottom of the computer. Slide the base toward the rear of the computer to remove it.
4. Remove the PCI card(s) (refer to *Removing PCI Cards* on page 16).
5. Remove PCI card and assembly (refer to *PCI Riser Card Removal/Installation* on page 19).
6. Disconnect the fan wire from the main logic board before removing the fan and crossbar.
7. Remove the CPU card (refer to *Removing the CPU* on page 13).
8. Remove the cache card (refer to *Removing the Cache* on page 15).
9. Remove the VRAM (refer to *VRAM Removal/Installation* on page 11).
10. Remove the RAM (refer to *RAM Removal/Installation* on page 9).
11. Disconnect the cables attached to the MLB. Disconnect the power cable by pressing the retaining clip facing the front of the computer, then pulling straight up. Disconnect all other cables by pulling them straight up from their sockets.
12. Remove the eight screws that secure the logic board to the chassis.
13. Lift the edge of the MLB closest to the bezel and slide the MLB out of the chassis at an angle.

Figure 16: Main logic board removal

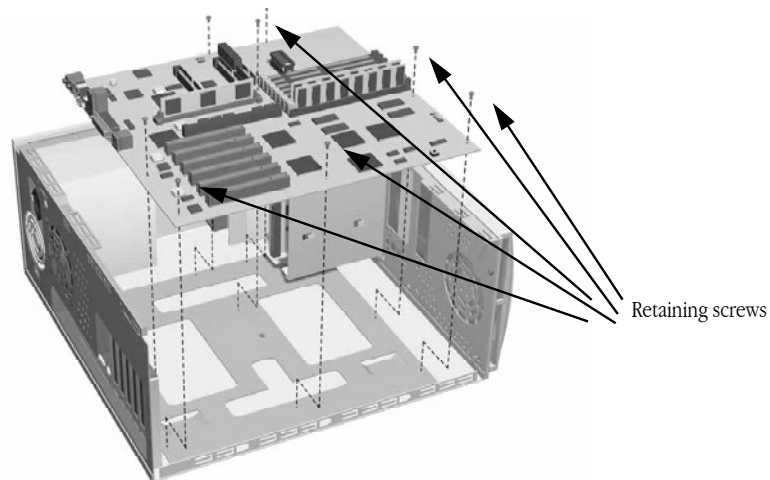

Installing the MLB

1. Lower the MLB into the chassis at an angle. Lay the board flat and align the mounting holes with the posts.
2. Replace the eight screws that secure the MLB to the chassis.
3. Reconnect the cables attached to the MLB. Connect the power cable by pressing the retaining clip facing the front of the computer, then pressing down. Connect all remaining cables to their connectors.

Note: If the cable does not have a directional connector, then connect it with the label on the cable connector facing the rear of the computer.

4. Install the RAM (refer to *RAM Removal/Installation* on page 9).
5. Install the VRAM (refer to *VRAM Removal/Installation* on page 11).
6. Install the Cache card (refer to *Installing the Cache* on page 15).
7. Install the CPU (refer to *Installing the CPU* on page 13).
8. Install the PCI Riser card and assembly (refer to *PCI Riser Card Removal/Installation* on page 19).
9. Install the PCI card(s) (refer to *PCI Cards Removal/Installation* on page 16).
10. Replace the base. The base is retained with two screws on the back in the bottom center of the computer and one directly on the bottom of the computer. Slide the base toward the front of the

computer to move into place.

11. Reset the CUDA (refer to **CUDA Reset** on page 4).

12. Install the chassis cover. (refer to **Chassis Cover Removal/Installation** on page 6).



Removal/Installation of Power Supply

Removing the Power Supply

1. Remove the chassis cover. (refer to **Chassis Cover Removal/Installation** on page 6).
2. Disconnect the logic board power connector from the MLB. The connectors will have red, white, blue, and black wires coming out of them that lead back to the power supply (refer to **MLB Diagram** on page 5). Disconnect the power cable by pressing in on the retaining clip and pulling straight up.
3. Remove the power connectors from all internal SCSI devices. These connectors are approximately one inch long with translucent white plugs with black, blue, yellow, red, and orange wires which lead back to the power supply.
4. Remove the four chassis retaining screws that hold the power supply in place. These screws are located on the outside rear of the computer, surrounding the power supply cooling fan.
 - the first screw is located above and to the left on the chassis
 - the second screw is located below and to the left on the chassis
 - the third screw is located above and to the right on the chassis
 - the fourth screw is located below and right on the chassis

CAUTION! Do not remove any screws unless you are sure that they are chassis retaining screws. There are retaining screws that hold the power supply components together as well. These screws must not be removed.

5. Pull the power supply directly up and out of the chassis.

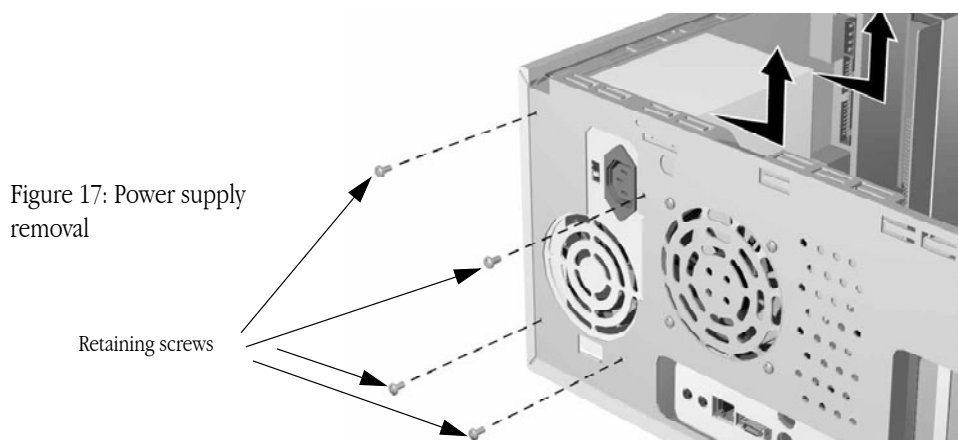

Installing Power Supply

1. Slide the power supply into place, making sure that it is seated properly.
2. Secure the power supply with the four retaining screws on the back of the chassis.
 - the first screw is located above and to the left on the chassis
 - the second screw is located below and to the left on the chassis
 - the third screw is located above and to the right on the chassis
 - the fourth screw is located below and right on the chassis
3. Connect the power connectors to all internal SCSI devices.
4. Connect the logic board power connector to the MLB.
5. Reset the CUDA. (refer to **CUDA Reset** on page 4).
6. Install the chassis cover (refer to **Chassis Cover Removal/Installation** on page 6).

This module was written and designed by:
Michael Scott Clay.

Additional contributions by:
Shane Nestle
Jeff Pryor

Edited by
Mark Wood
Laurie Veatch

This Power Computing module was written, edited and produced on a desktop publishing system using Power Computing system that use the Mac OS.

Every effort has been made to ensure that the information in the module is accurate. Power Computing is not responsible for printing or clerical errors.

Mention of third-party products is for informational purposes only and constitutes neither an endorsement nor a recommendation. Power Computing no responsibility with regard to the performance or use of these products.



© 1997 Power Computing Corporation

Power Computing Corporation
2400 S. IH-35
Round Rock, Texas 78681-7903